

 **JAMES BAROUD**

EN USER GUIDE

FR Guide de L'utilisateur

DE Benutzerhandbuch

ES Guía del usuario

PT Guia de utilizador

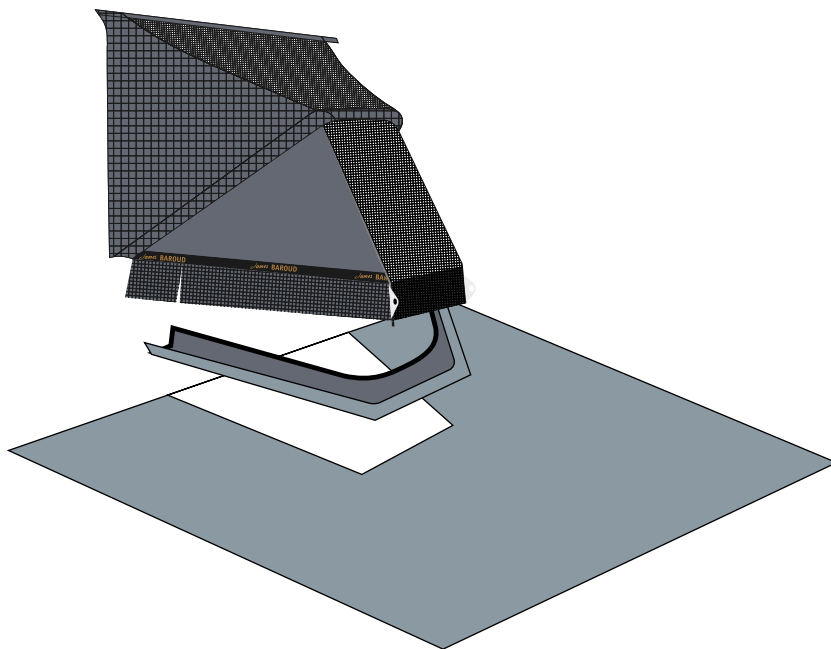

Tunnel Odyssey

1

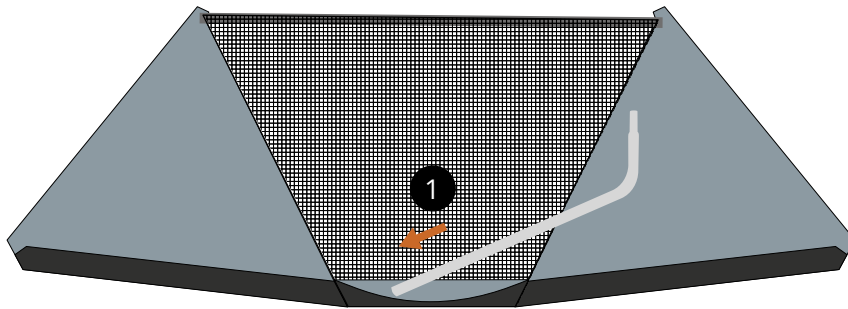

2

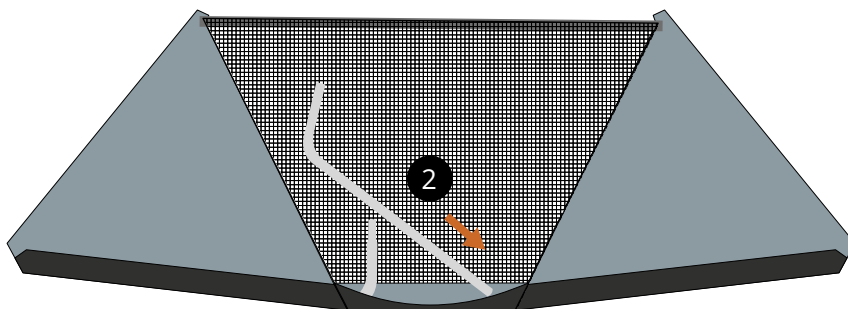

3

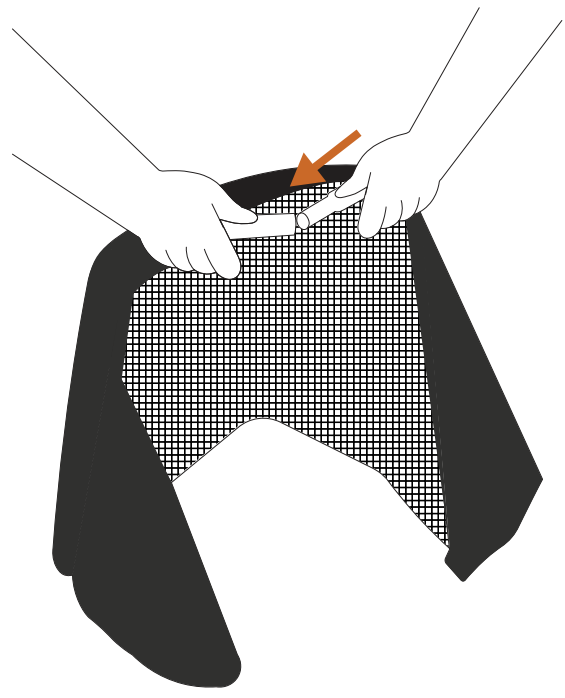

4

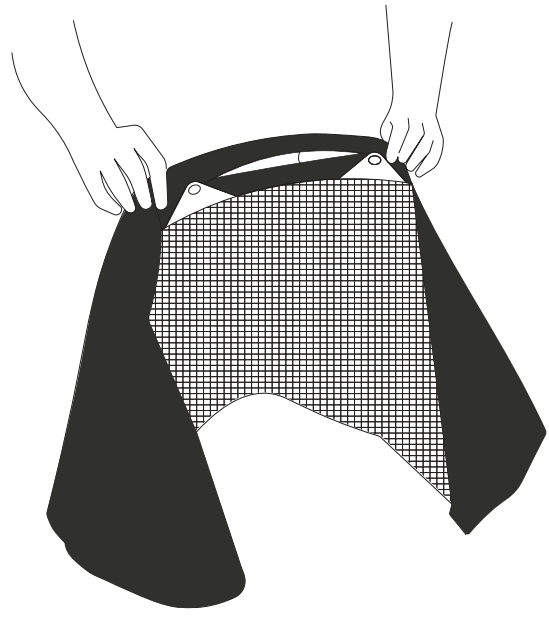

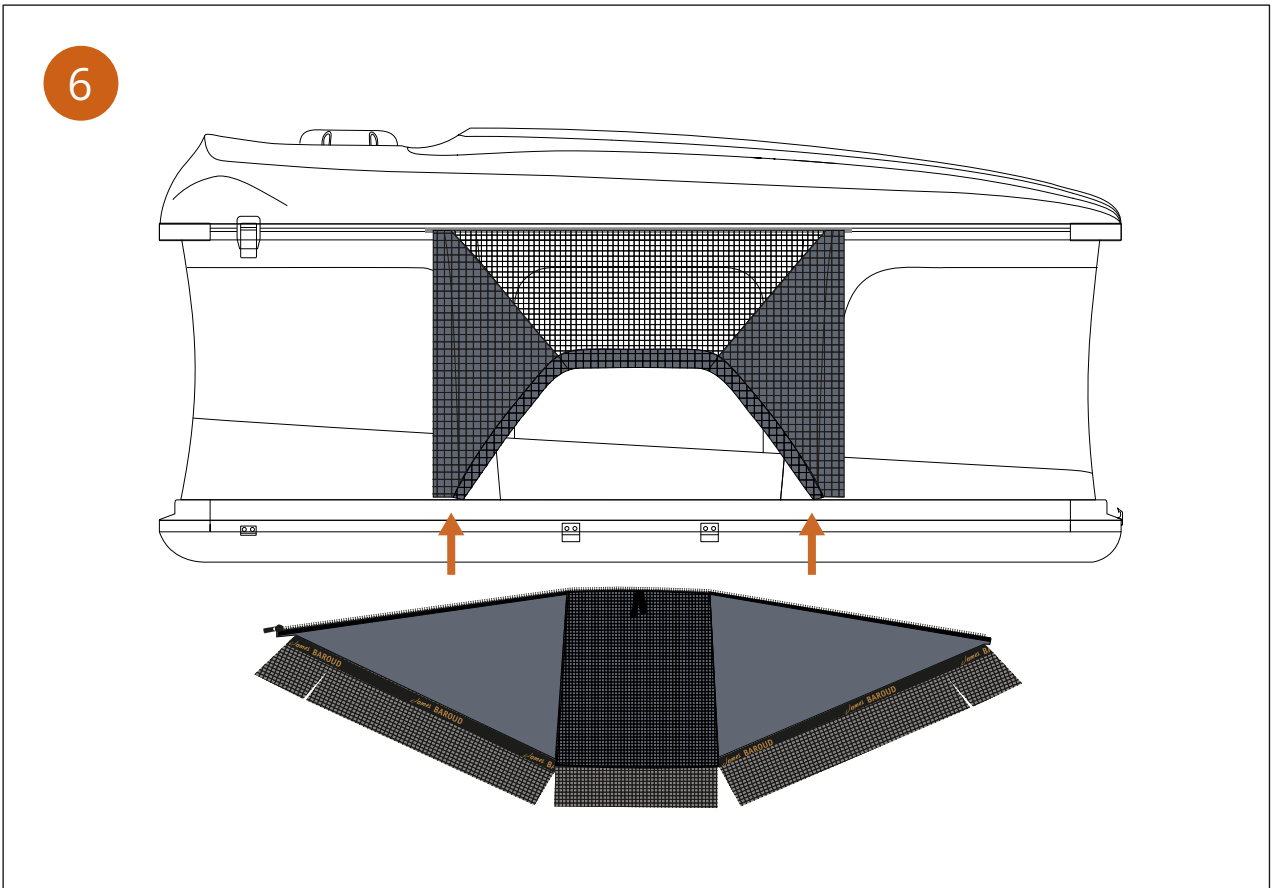
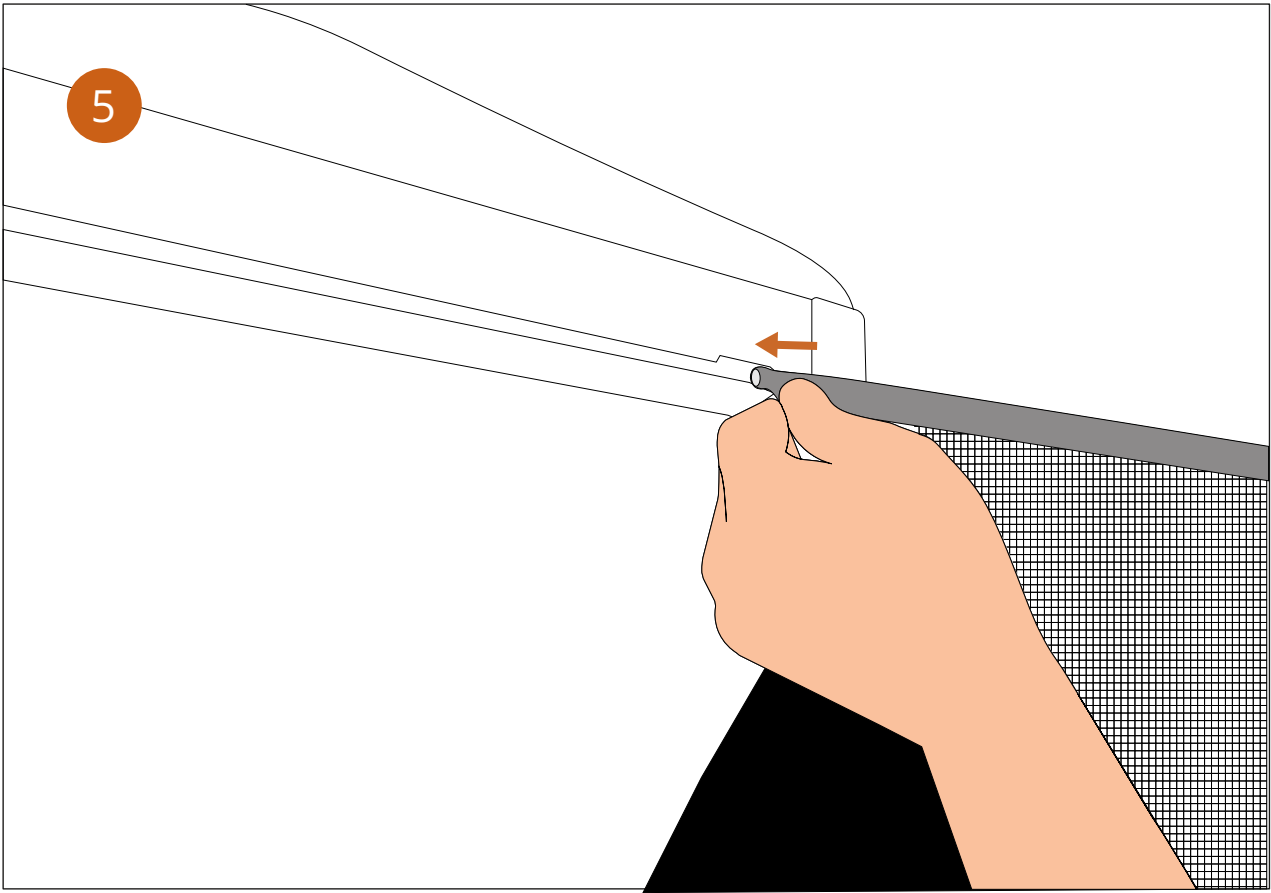

7

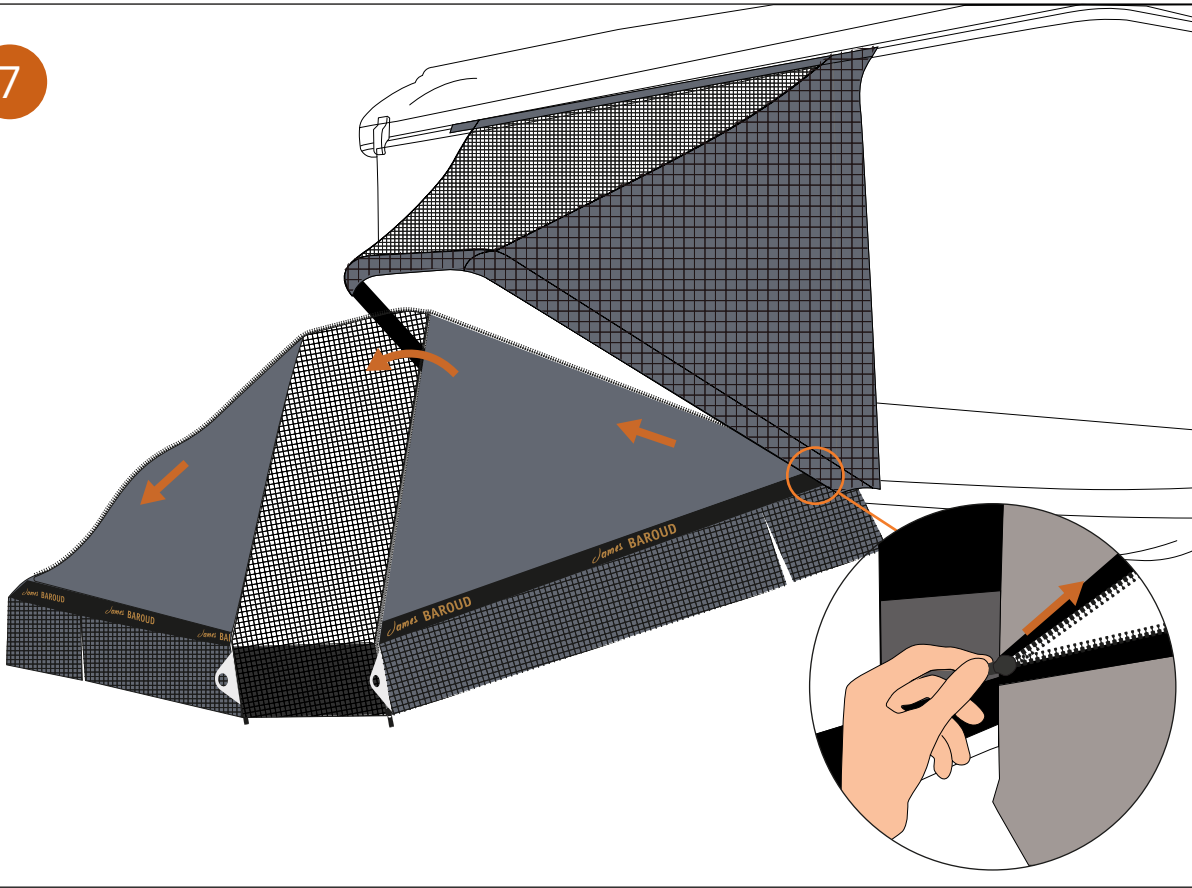

8

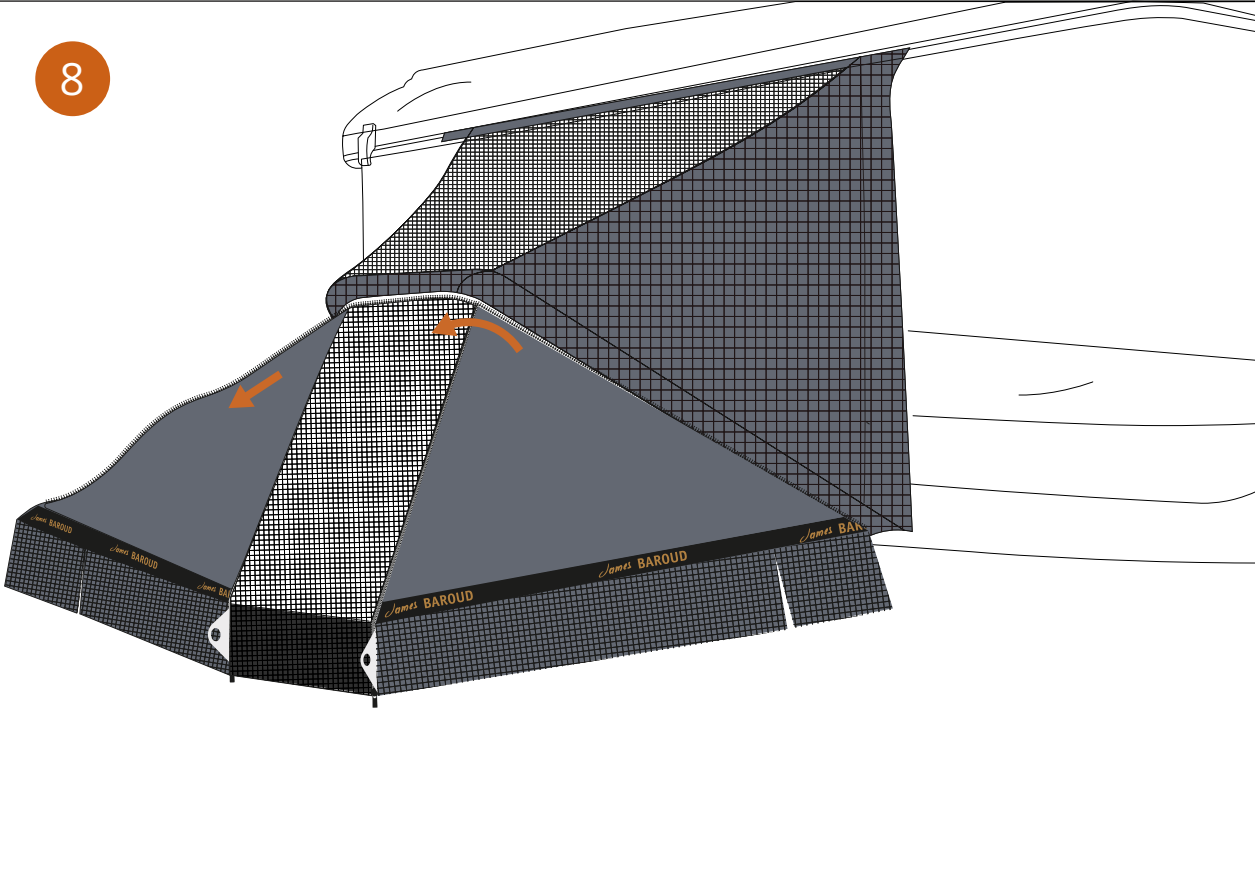

9

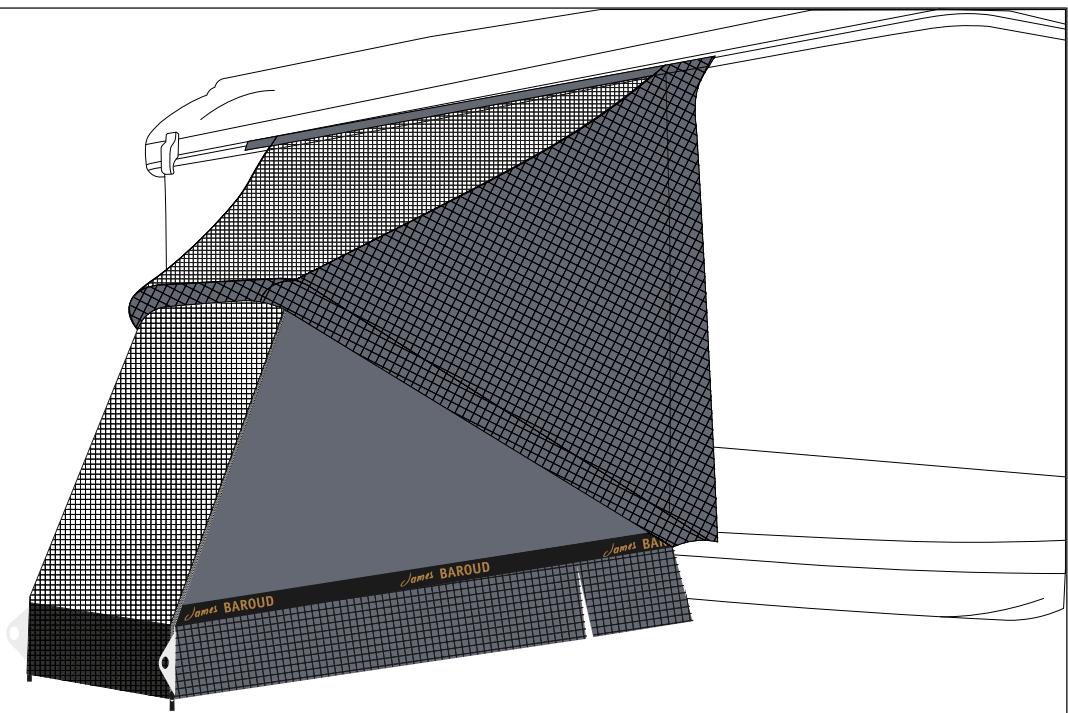

10

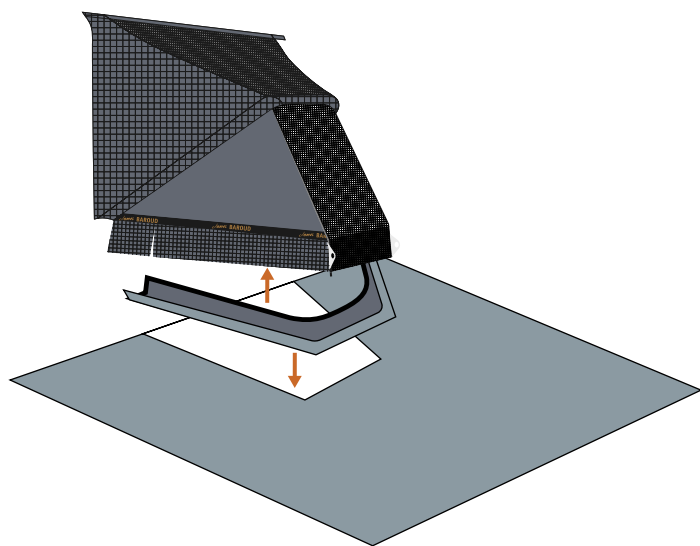

11

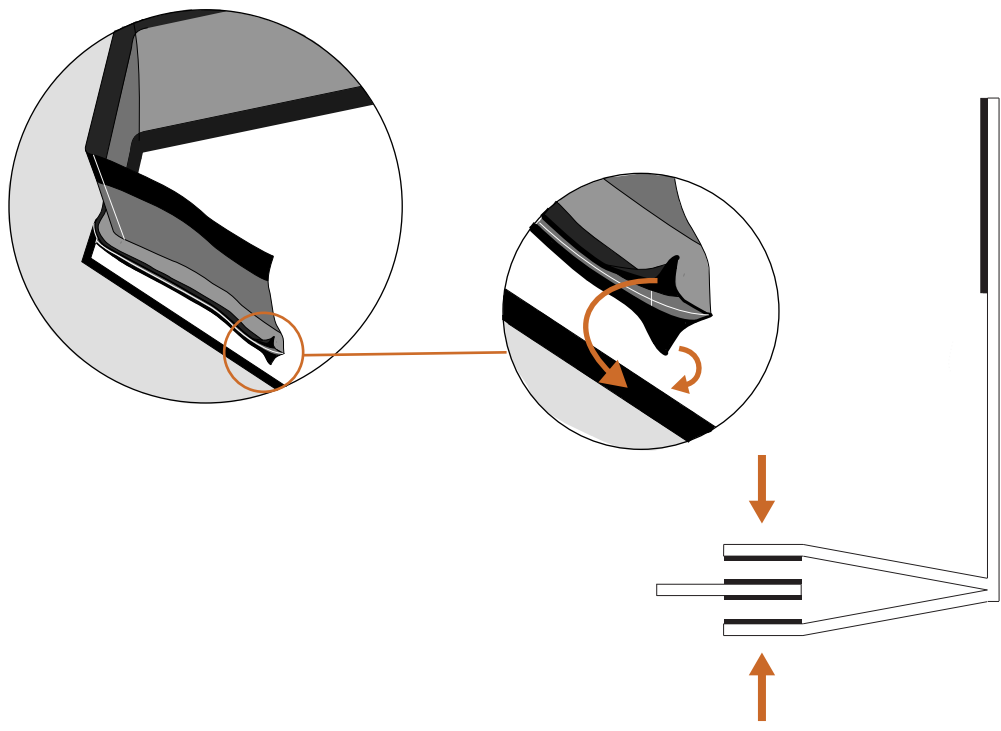

12

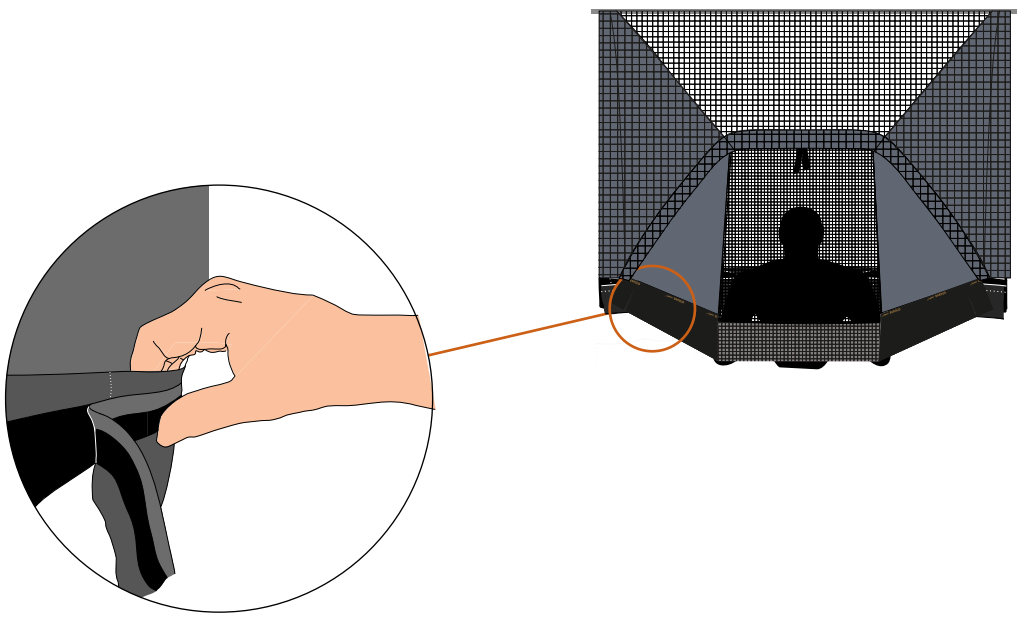

COMPONENTS

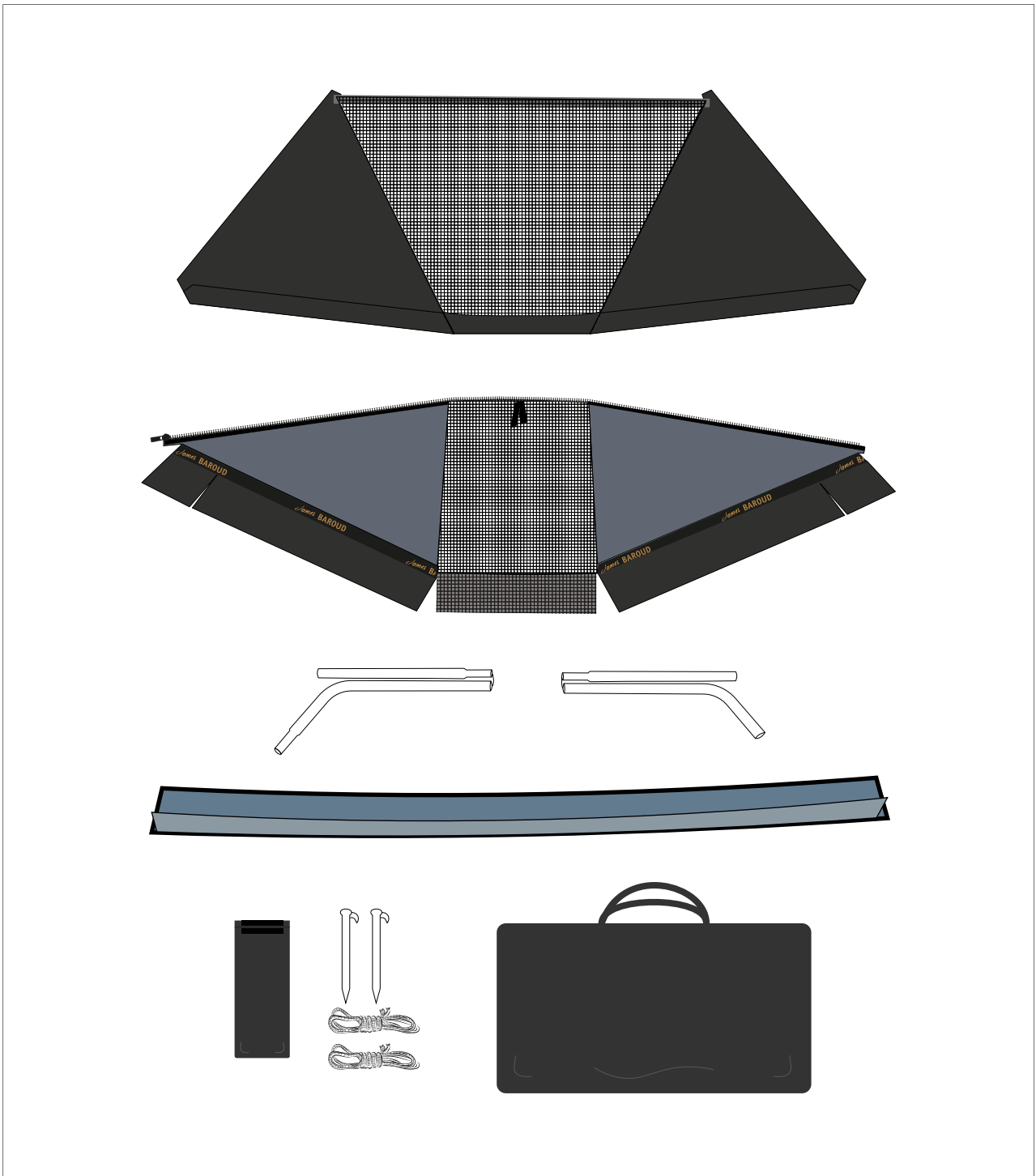

READ MORE ON

jamesbaroud.com

[@jamesbaroud](https://www.instagram.com/jamesbaroud)

